



POOL FITTINGS & CLEANERS



POOL FITTINGS

POOL FITTINGS

POOL FITTINGS & CLEANERS

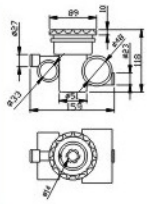

Products	Jet
Model	WL-APH02
Colour	White
Material	ABS

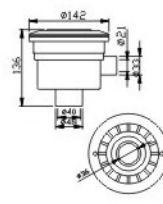

Products	Jet
Model	WL-APH03
Colour	White
Material	ABS

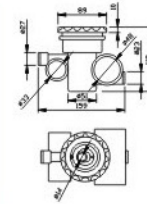

Products	Jet
Model	WL-AXP01
Colour	White
Material	ABS

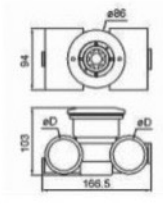

Products	Jet
Model	WL-BPH02
Colour	White
Material	ABS

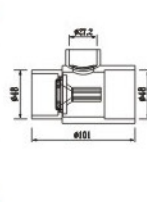

Products	Jet
Model	WL-ASL01
Colour	White
Material	ABS

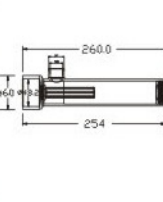

Products	Jet
Model	WL-ASL02
Colour	White
Material	ABS

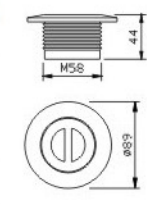

Products	Suction Head
Model	WL-ACW01
Colour	White
Material	ABS

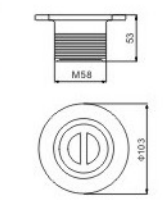

Products	Suction Head
Model	WL-ACW02
Colour	White
Material	ABS

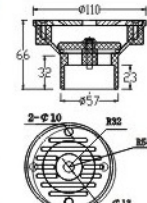

Products	Adjustable Inlet (1.5")
Model	WL-AJH01
Colour	White
Material	ABS

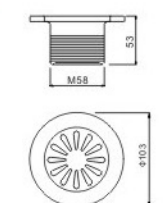

Products	Adjustable Inlet
Model	WL-AJH02
Colour	White
Material	ABS

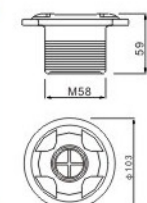

Products	Adjustable Inlet
Model	WL-AJH03
Colour	White
Material	ABS

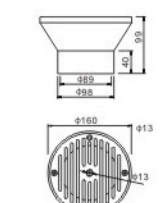

Products	Adjustable Inlet (3")
Model	WL-AJH31
Colour	White
Material	ABS

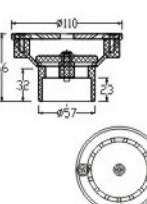

Products	Adjustable Inlet
Model	WL-AJH04
Colour	White
Material	ABS

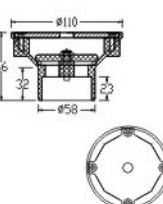

Products	Adjustable Inlet
Model	WL-AJH05
Colour	White
Material	ABS

POOL FITTINGS & CLEANERS

POOL FITTINGS

POOL FITTINGS & CLEANERS

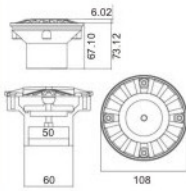

Products	Floor inlet
Model	PADF2825C
Colour	White
Material	ABS

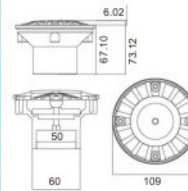

Products	Floor inlet
Model	PADF2825V
Colour	White
Material	ABS

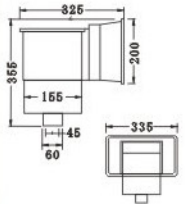

Products	Wide Mouth Wall Skimmer
Model	WL-APZ01
Colour	White
Material	ABS

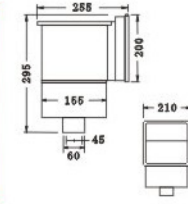

Products	Standard Wall Skimmer
Model	WL-APZ02
Colour	White
Material	ABS

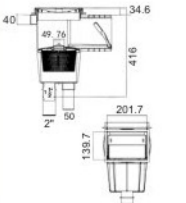

Products	Standard Skimmer
Model	PA00249C
Colour	White
Material	ABS

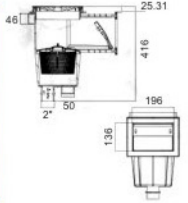

Products	Standard Skimmer
Model	PA00249V
Colour	White
Material	ABS

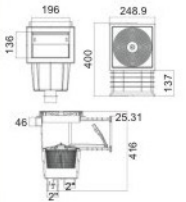

Products	Standard Skimmer
Model	PA00249.1V
Colour	White
Material	ABS

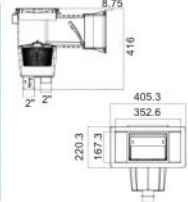

Products	Wide Mouth Skimmer
Model	PA00250C
Colour	White
Material	ABS

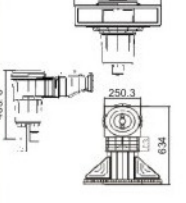

Products	Wide Mouth Skimmer
Model	PA00252C
Colour	White
Material	ABS

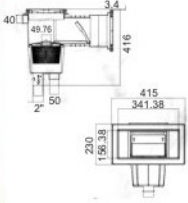

Products	Wide Mouth Skimmers
Model	PA00250V
Colour	White
Material	ABS

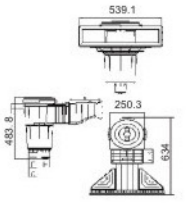

Products	Wide Mouth Skimmer
Model	PA00252.1V
Colour	White
Material	ABS

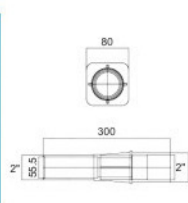

Products	Wall Conduit
Model	PA00324
Colour	Gray
Material	ABS

POOL FITTINGS & CLEANERS

MAIN DRAINS

POOL FITTINGS & CLEANERS

The main drains are available in a wide range of styles and sizes to satisfy any installation requirement of any concrete residential or commercial pools. These main drains are injection-molded of ABS, which resists chemical attack.

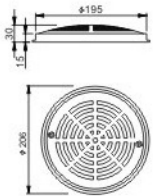

Products	Round Main Drain
Model	WL-ADP197
Colour	White
Material	ABS

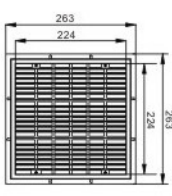
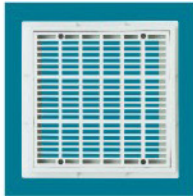

Model	WL-ADP263
Size	263X263mm
Colour	White
Thickness	35mm

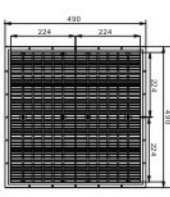
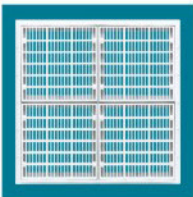

Model	WL-ADP490
Size	490X490mm
Colour	White
Thickness	66mm

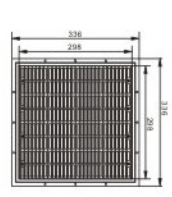
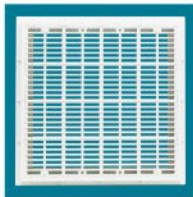

Model	WL-ADP336
Size	336X336mm
Colour	White
Thickness	35mm

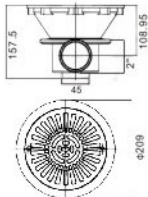

Products	Drains
Model	PADF1467C
Colour	White
Material	ABS

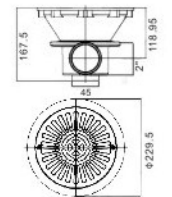

Products	Drains
Model	PADF1467V
Colour	White
Material	ABS



ANTI-SUCTION MAIN DRAINS

POOL FITTINGS & CLEANERS

Features:

- Curved surface design, anti-suction.
- VGB compliant and tested to ANSI/APSP-16 standards.
- UV-resistant, corrosion resistant, not easy to fade, longer life time.
- Meets various flow rate requirements.

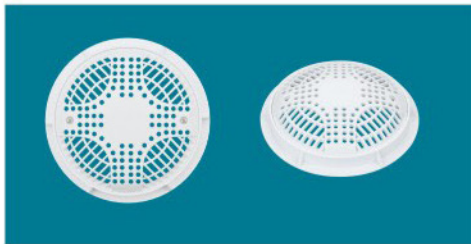
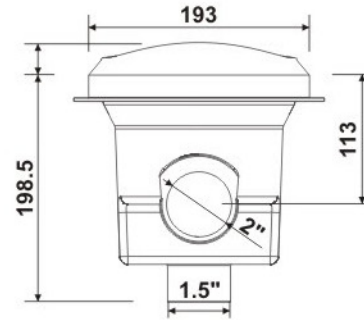
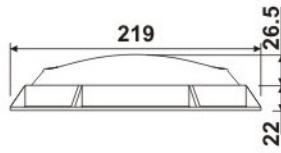
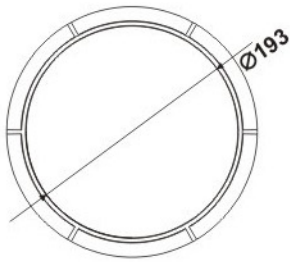

WL-JDP200AL

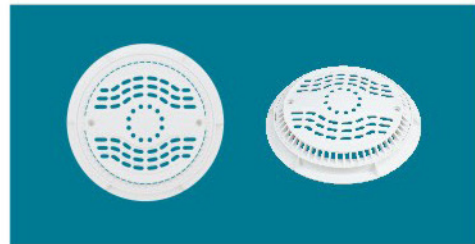

WL-JDP200BL



WL-JDP200AH



WL-JDP200BH

Model	Specification	Outlet	Cover Dia. (mm)	Height	Material	Max Flow Rate (m ³ /h)
WL-JDP200AL	cover + frame	—	193	22	ABS	33.5
WL-JDP200AH	cover+ body	side 2 bottom1.5"	193	198.5	ABS	33.5
WL-JDP200BL	cover + frame	—	193	22	ABS	33.5
WL-JDP200BH	cover+ body	side 2 bottom1.5"	193	198.5	ABS	33.5

ANTI-SUCTION MAIN DRAINS

POOL FITTINGS & CLEANERS

Features:

- Curved surface design, anti-suction.
- VGB compliant and tested to ANSI/APSP-7,2006 standards.
- Manufactured from UV- resistant engineered polymers.
- Used in new construction or to retrofit into existing Laswim frames.
- Meets various flow rate requirements.

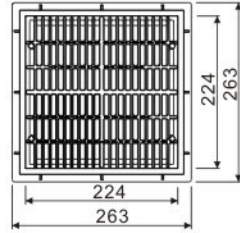

WL-FDP9"

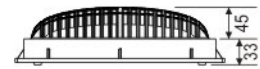
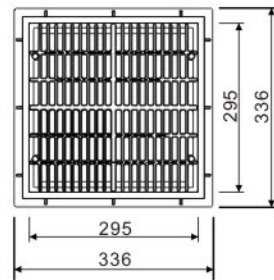

WL-FDP12"

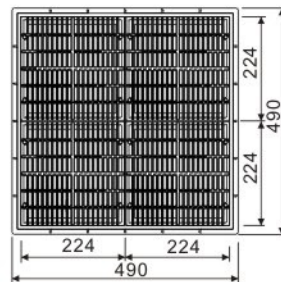
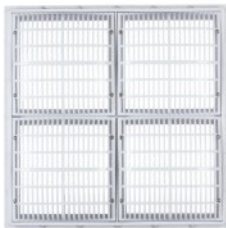

WL-FDP18"

Model	Size (inch/ mm)	Thickness (mm)	Material	Design Flow (m ³ /h)
WL-FDP9"	9" x 9" 263mm x263mm	70	ABS	23
WL-FDP12"	12" x 12" 336mm x336mm	78	ABS	88
WL-FDP18"	18" x 18" 490mm x490mm	100	ABS	93

GUTTER GRATINGS

POOL FITTINGS & CLEANERS

Gutter grating is molded in white UV resistant ABS. Top of grating features an anti-slip finish and it is composed of individual units connecting along a central spine. This design allows for easier installation without the need for cutting also allowing the grating to curve as necessary.

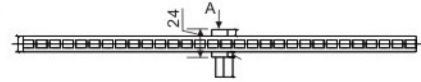
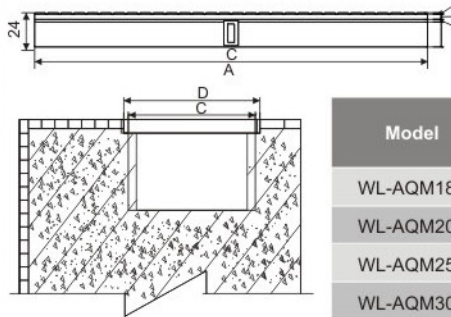
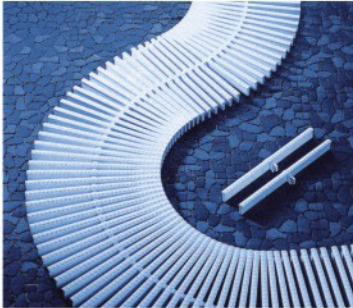

Model	Width of Gutter D(mm)	Width of Panel C(mm)
WL-AQM180	180	178
WL-AQM200	200	198
WL-AQM250	250	248
WL-AQM300	300	298

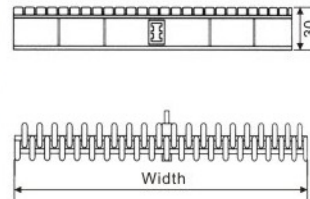
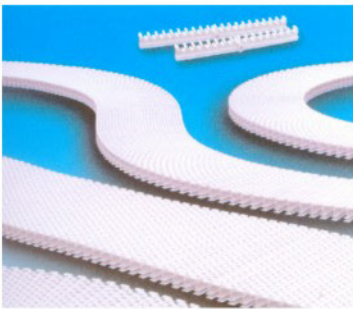

Model	Width of Gutter D(mm)	Material
WL-BQM180	180	ABS
WL-BQM250	250	ABS
WL-BQM300	300	ABS

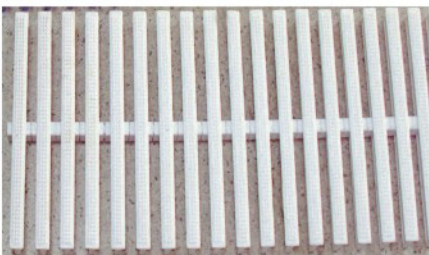

Model	Height×Width(mm)	Material
WL-CQM180	25×180	ABS
WL-CQM250	25×250	ABS
WL-CQM300	25×300	ABS

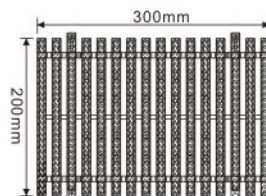

Model	Length×Width(mm)	Material
WL-DQM200	300×200	ABS
WL-DQM350	350×250	ABS
WL-DQM375	375×250	ABS

GUTTER GRATINGS

POOL FITTINGS & CLEANERS

Features:

- Comply with the standard of EN-13451 and CJJ122-2008.
- Anti-slip, safe, super strong, durable.
- UV-resistant, not easy to fade or break, longer using life.
- To be easy to install and flexible to meet a variety of different swimming pool specifications.
- Composed of Part A and Part B as below drawing, Length is adjustable.
- Can make an arc with minimum radius of 625mm.

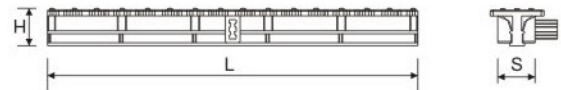
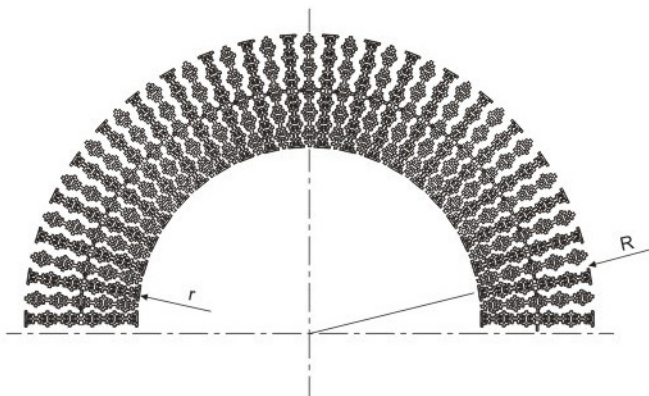
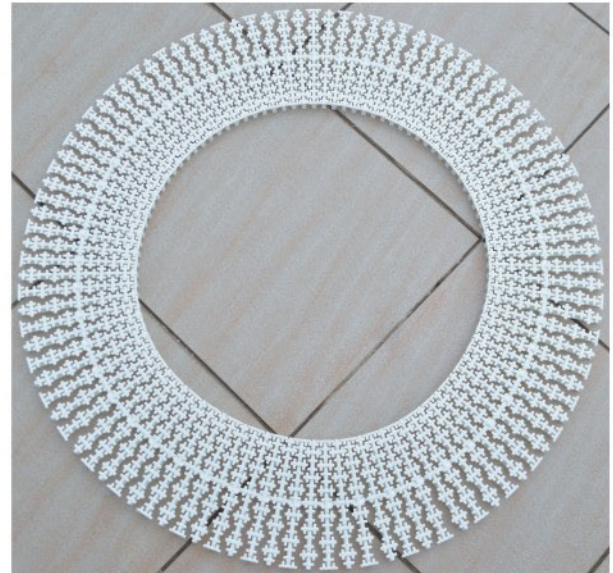
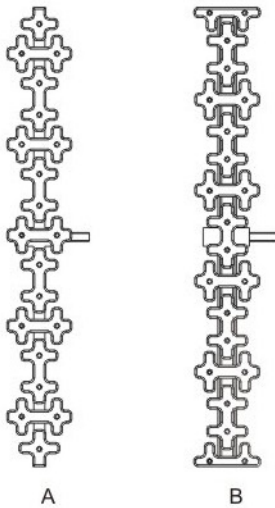
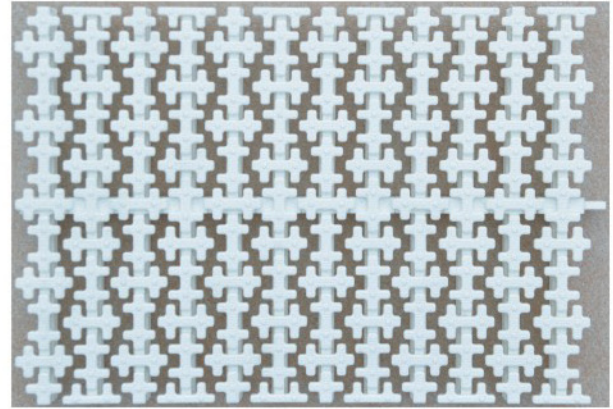

Model	L(mm)	S(mm)	H(mm)	R(mm)	r(mm)
WL-HQM250	250	29	25	625	375

SAFETY CHECK VALVE

POOL FITTINGS & CLEANERS



WL-DZF50A/B

Safety Check Valve is an essential accessory for circulating pumps. Its main function is to avoid damaging the impeller when pump stops working.

LASWIM Safety Check Valve is specially designed for swimming pool and spa and it relies on the flow of the liquid itself to turn on and turn off the seal baffle automatically, then form the directional flow of the liquid. It ensures the directional flow of water from swimming pool and spa and prevents water from backflow.

Features:

- Transparent Lid, convenient to watch flow direction of water.
- Seal baffle and stainless steel spring with numerous tests ensure high performance and reliable quality.
- Being made of high quality engineering plastics, our Safety check valve is in high temperature resistance and corrosion resistance, which can adapt to acidic or alkaline fluid in temperature 5-50°C.
- Safety Check Valve in metric or imperial is optional, facilitating the installation.

DZF series Safety Check Valve has two models: model A and model B, model A : 2" model B : Φ63mm

Model	A	B	C	D
DZF50-A	Φ2"	139	190	Φ134
DZF50-B	Φ63	139	190	Φ134

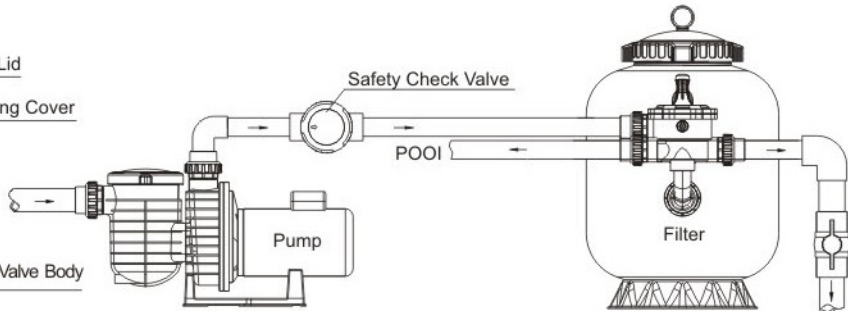
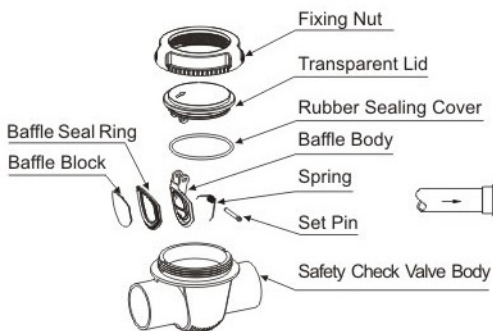
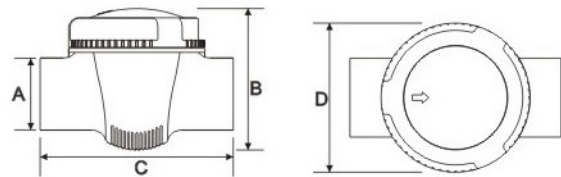

WL-DZF Series Exploded Drawing And Installation Diagram

LADDERS

POOL FITTINGS & CLEANERS

1. Grab Rails and Anchor Sockets

Closed rail design and constructed with polished Stainless Steel and Anchor Socket.

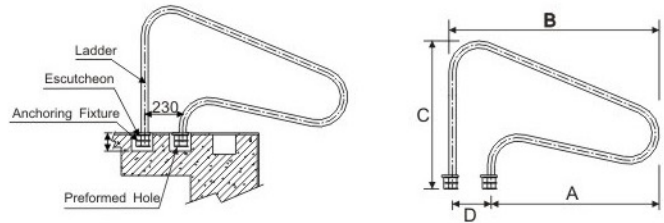

Model	A (mm)	B (mm)	C (mm)	D (mm)	Specification
WL-SRG	1000	1250	880	230	φ42

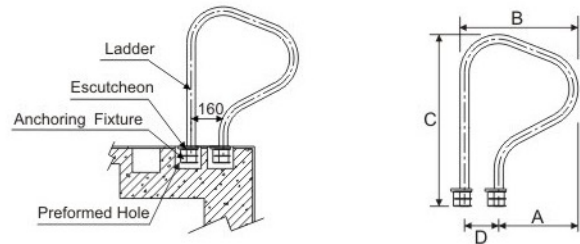

Model	A (mm)	B (mm)	C (mm)	D (mm)	Specification
WL-SRB	375	555	805	160	φ42

2. Ladder For Overflow Pool

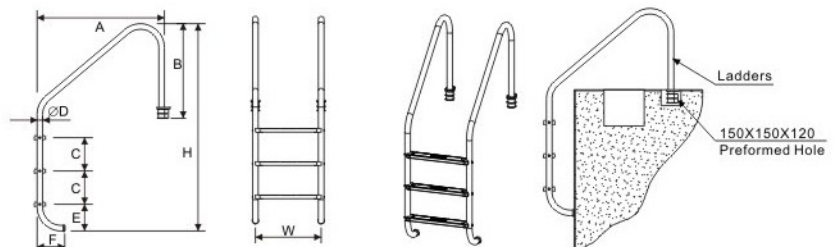

Model	A (mm)	B (mm)	C (mm)	∅D (mm)	E (mm)	F (mm)	H (mm)	W (mm)
WL-KFT202	957	710	250	42	200	208	1306	500
WL-KFT203	957	710	250	42	200	208	1556	500
WL-KFT204	957	710	250	42	200	208	1806	500
WL-KFT205	957	710	250	42	200	208	2056	500

LADDERS

POOL FITTINGS & CLEANERS

3. Ladders for embedded pools. Handrails in hand polished stainless steel pipe. Steps in stainless steel and anti-slip. Complete with anchoring fixtures and earth connection. Easy installation (with diameter 42mm) .



Anti-Slip Steps

Anti-Slip Steps

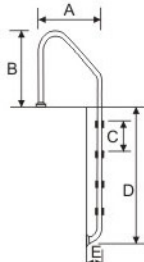
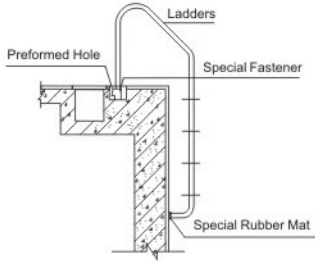

Model	A (mm)	B (mm)	C (mm)	D (mm)	E (mm)	F (mm)	Specification
WL-SL202	645	720	250	580	170	500	Φ42
WL-SL203	645	720	250	830	170	500	
WL-SL204	645	720	250	1080	170	500	
WL-SL205	645	720	250	1330	170	500	

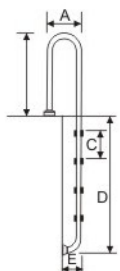
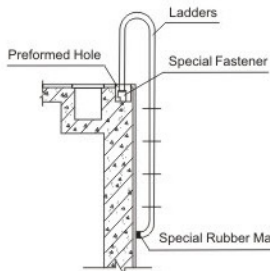

Model	A (mm)	B (mm)	C (mm)	D (mm)	E (mm)	F (mm)	Specification
WL-MC202	360	630	250	680	170	500	Φ42
WL-MC203	360	630	250	930	170	500	
WL-MC204	360	630	250	1180	170	500	
WL-MC205	360	630	250	1430	170	500	

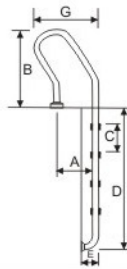
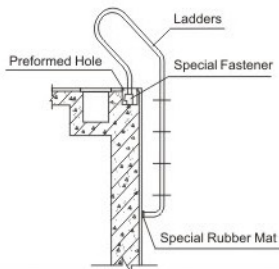

Model	A (mm)	B (mm)	C (mm)	D (mm)	E (mm)	F (mm)	G (mm)	Specification
WL-SF202	320	640	250	670	170	500	490	Φ42
WL-SF203	320	640	250	920	170	500	490	
WL-SF204	320	640	250	1170	170	500	490	
WL-SF205	320	640	250	1420	170	500	490	

POOL FITTINGS & CLEANERS

VACUUM HEADS. & JET VACS.

 Model: 5288 Economy liner Vac Head	 Model: 6098 Deluxe large vac. Head cast iron weighted	 Model: 6088 Deluxe large vac. Head cast iron weighted w/side brush	 Model: 5238 Deluxe liner Vac. Head with bumper(cast iron weighted)	 Model: 5488 Triangular liner vac head w/ swivel
 Model: 5528 Deluxe triangular transparent cast iron weighted vac head	 Model: 5518 Flexible vacuum head for in-ground pool	 Model: 5538 Flexible vacuum head w/ side brush for in-ground pool	 Model: 8028 Flexible Vac head with Pressure release and EZ-Clip	 Model: 9018 Vac head with 4 wheels, Alu body, plastic handle(34.5*13cm)
 Model: 9028 Deluxe large Vac head, 4 wheels, Alu body, plastic handle(44.5*13cm)	 Model: 5688 Economy jet vacuum w/brush for small above ground pool	 Model: 6898 Jet vac kit w/ 5 section pole of 48*120cm	 Model: 9038 Deluxe large Jet vac with brush for spa & splasher	 Model: 9378 Jet vac kit w/3 section pole of 52*135cm

BRUSHES.

 Model: 5248 10*26cm Hi-grade Stainless steel algae brush	 Model: 5258 18*45cm Deluxe wall brush with aluminum back	 Model: 5256 18*45cm Deluxe stainless steel algae brush w/ Alu back	 Model: 5368 18*45cm standard curved polybristle wall brush	 Model: 5858 10*26cm polybristle wall brush
 Model: 5778 Scrubber pad brush	 Model: 6228 Finger brush	 Model: 8048 Oversized polybristle wall brush w/ EZ-clip	 Model: 8908 Flexible brush w/ Alu handle EZ-clip and extra bristle	 Model: 8258 Water line scrub pad with detergent tank and EZ-clip

CHEMICAL DISPENSERS & TEST KITS.

 Model: 5638 Chemical dispenser for 3* tablets	 Model: 5278 Deluxe large chemical dispenser for 3* tablets	 Model: 5338 Chemical dispenser for 1 1/2* tablets	 Model: 5298 Basic PH & CL test kit	 Model: 6028 Test kit refill bottle (20 C.C.)
--	---	--	---	---

POOL FITTINGS & CLEANERS

LEAF SKIMMERS.

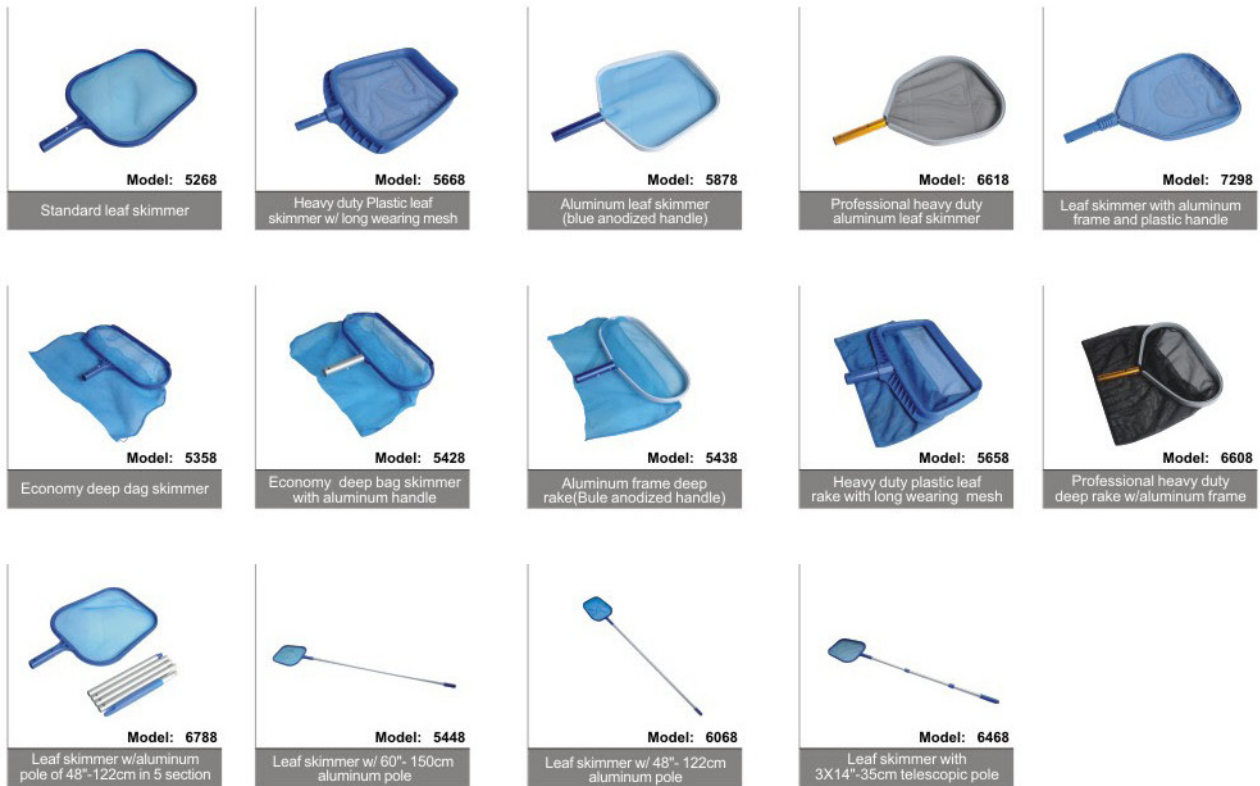

HOSE

HOSE



Model	Description
WL-BXG01	Extruded PE. ϕ 1 1/2" - 7M
WL-BXG02	Extruded PE. ϕ 1 1/2" - 9M
WL-BXG03	Extruded PE. ϕ 1 1/2" - 11M
WL-BXG04	Extruded PE. ϕ 1 1/2" - 13M
WL-BXG05	Extruded PE. ϕ 1 1/2" - 15M
WL-BXG06	Extruded PE. ϕ 1 1/2" - 30M
WL-BXG07	Extruded PE. ϕ 1 1/2" - 50M

HOSE



Model	Description
8288	Vacuumhose ϕ 1/4 ; 1m persection-36m
8888	Vacuumhose ϕ 1/2 ; 1m persection-36m
8750	Vacuumhose ϕ 1/4 ; 1m persection-50m
8769	Vacuumhose ϕ 1/2 ; 1m persection-50m

HOSE



Model	Description
8588	Spiralwound EVA. ϕ 1 1/4" -6M
8608	Spiralwound EVA. ϕ 1 1/4" -9M
8628	Spiralwound EVA. ϕ 1 1/4" -12M
8648	Spiralwound EVA. ϕ 1 1/2" -9M
8468	Spiralwound EVA. ϕ 1 1/2" -11M
8138	Spiralwound EVA. ϕ 1 1/2" -13M
8688	Spiralwound EVA. ϕ 1 1/2" -15M

Telescopic Poles.



Model	Description
6348	2X120 cm Ribbed pole-0.8mm thick
6328	2X240 cm Ribbed pole-0.8mm thick
6638	3X120 cm Ribbed pole-0.8mm thick
6358	3X300 cm Ribbed pole-0.8mm thick
7548	2X240 cm Ribbed pole-1.1mm thick
6359	2X300 cm Ribbed pole-1.1mm thick
7358	3X300 cm Ribbed pole-1.1mm thick

THERMOMETERS.

Model: 8988 Swivel Cuff for vacuum hose(1pc)	Model: 5498 Economy thermometer	Model: 5508 Large thermometer	Model: 5808 Jim Buoy thermometer	Model: 5828 Deluxe round thermometer
Model: 5848 Deluxe floating thermometer with string attachment	Model: 6518 Jumbo easy read thermometer	Model: 5838 Floating animal thermometer in 4 styles	Model: 7258 Floating cool pool animal thermometer in 3 styles	

FOUNTAINS & WALL SKIMMERS & SPARE PARTS

Model: 8858 Waterfall fountain	Model: 9798 Flower waterfall fountain	Model: 5678 In line feeder	Model: 5798 Plastic pole hanger (2pcs) w/screws	Model: 5398 Quick snap butterfly clips (4PCS)
Model: 5048 Complete return inlet	Model: 5478 Standard vacuum head handle	Model: 6658 Replacement bag for Jet Vac head	Model: 9068 Hose Reel-carries vacuum hose up to 13m in length	Model: 6688 ZAP VAC automatic pool cleaner (hose included)climb walls
Model: 5468 Long lock pin for vacuum handle (4PCS)	Model: 6178 NPT tie-in for American standard (2PCS)	Model: 6188 BSPT tie-in for European standard (2PCS)	Model: 6699 ZAP VAC automatic pool cleaner (hose included)climb walls	



Model	Description
8341	Above ground pool cover reel W/ABS frame for c: 3-1/4" & 1-1/2" tubes(not include AL pole)
8341-1	Pole for 8341, 3'2.1m (hexagonal)
8341-2	Pole for 8341, 3'2.7m (hexagonal)
8341-3	Pole for 8341, 3'3.55m (hexagonal)



Model	Description
8342	Above ground pool Solar Reel System(not include AL pole)
8342-1	Pole for 8342, 3X2.1M
8342-2	Pole for 8342, 3X2.44M

POOL FITTINGS & CLEANERS

